

1. Scope

This specification is applied to Multilayer Ceramic Chip Capacitor (MLCC) for use in electric equipment for the voltage is ranging from 4V to 50V.

The series suitable for general electrics circuit, telecommunications, personal computers and peripheral, power circuit and mobile application. **(This product is compliant with the RoHS & HF.)**

2. Parts Number Code

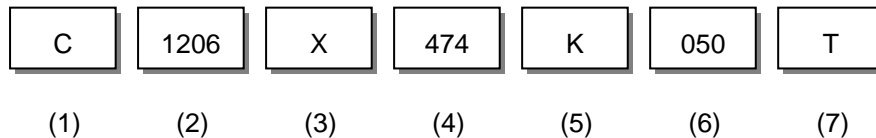

(1) Product

Product Code	
C	Multilayer Ceramic Chip Capacitor

(2) Chip Size

Code	Length×Width	unit : mm(inch)
0201	0.60× 0.30	(.024× .011)
0402	1.00× 0.50	(.039× .020)
0603	1.60× 0.80	(.063× .031)
0805	2.00× 1.25	(.079× .049)
1206	3.20× 1.60	(.126× .063)
1210	3.20× 2.50	(.126× .098)
1808	4.60× 2.00	(.181× .079)
1812	4.60× 3.20	(.181× .125)
1825	4.60× 6.35	(.181× .250)
2208	5.70× 2.00	(.220× .197)
2211	5.70× 2.80	(.220× .110)
2220	5.70× 5.00	(.220× .197)
2225	5.70× 6.35	(.220× .250)

(3) Temperature Characteristics

Code	Temperature Characteristic	Temperature Range	Temperature Coefficient
N	NPO	-55°C~+125°C	30 ppm/°C
X	X7R	-55°C~+125°C	± 15%
B	X5R	-55°C~+85°C	± 15%
R	X7S	-55°C~+125°C	± 22%
S	X6S	-55°C~+105°C	± 22%
D	X5S	-55°C~+85°C	± 22%
Y	Y5V	-30°C~+85°C	+22/-82%
Z	Z5U	+10°C~+85°C	+22/-56%
E	Y5U	-30°C~+85°C	+22/-56%

(4) Capacitance

unit : pico farads(pF)

Code	Nominal Capacitance (pF)
5R0	5.0
120	12.0
151	150.0
222	2,200.0
473	47,000.0
474	470,000.0
105	1,000,000.0
106	10,000,000.0

※. If there is a decimal point, it shall be expressed by an English capital letter R

(5) Capacitance Tolerance

Code	Tolerance	Nominal Capacitance
B	± 0.10 pF	Less Than 10 pF (Include 10 pF)
C	± 0.25 pF	
D	± 0.50 pF	More Than 10 pF
E	± 1.00 pF	
F	± 1.00 %	
G	± 2.00 %	
J	± 5.00 %	
K	± 10.0 %	
M	± 20.0 %	
Z	+80/-20 %	

(6) Rated Voltage

Code	Rated Voltage (Vdc)
004	4
007	6.3
010	10
016	16
025	25
035	35
050	50

(7) Tapping

Code	Type
T	Tape & Reel
B	Bulk

3. Nominal Capacitance and Tolerance

3.1 Standard Combination of Nominal Capacitance and Tolerance

Class	Characteristic	Tolerance		Nominal Capacitance
I	NPO	Less Than 10 pF	B (± 0.10 pF)	0.5,1,1.5,2,2.5,3
			C (± 0.25 pF)	0.5,1,1.5,2,2.5,3,3.5,4,4.5,5
			D (± 0.50 pF)	5,6,7,8,9,10
			E (± 1.00 pF)	6,7,8,9,10
		More Than 10 pF	F (± 1.00 %)	E-12, E-24 series
			G (± 2.00 %)	
J (± 5.00 %)				
K (± 10.0 %)				
II	X7R/ X7S/ X5R X6S/ X5S	K (± 10.0 %), M (± 20.0 %)		E-3, E-6 series
	Y5V	M (± 20.0 %), Z (+80/ -20 %)		E-3 series
	Z5U			
	Y5U			

3.2 E series(standard Number)

Standard No.	Application Capacitance											
E-3	1.0				2.2				4.7			
E-6	1.0		1.5		2.2		3.3		4.7		6.8	
E-12	1.0	1.2	1.5	1.8	2.2	2.7	3.3	3.9	4.7	5.6	6.8	8.2
E-24	1.0	1.2	1.5	1.8	2.2	2.7	3.3	3.9	4.7	5.6	6.8	8.2
	1.1	1.3	1.6	2.0	2.4	3.0	3.6	4.3	5.1	6.2	7.5	9.1

4. Operation Temperature Range

Class	Characteristic	Temperature Range	Reference Temp.
I	NPO (N)	-55°C ~ +125°C	25°C
II	X7R (X)	-55°C ~ +125°C	25°C
	X7S (R)	-55°C ~ +125°C	25°C
	X5R (B)	-55°C ~ +85°C	25°C
	X5S (D)	-55°C ~ +85°C	25°C
	X6S (S)	-55°C ~ +105°C	25°C
	Y5V (Y)	-30°C ~ +85°C	25°C
	Z5U (Z)	+10°C ~ +85°C	25°C
	Y5U (E)	-30°C ~ +85°C	25°C
Other		-25°C ~ +85°C	25°C

5. Storage Condition

Storage Temperature : 5 to 40°C

Relative Humidity : 20 to 70 %

Storage Time : 12 months max.

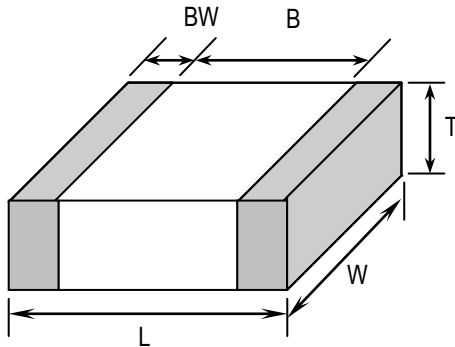
6. Dimensions
6.1 Configuration and Dimension :

Unit:mm

TYPE	L	W	T (max)	B (min)	BW (min)
0201	0.60± 0.03	0.30± 0.03	0.33	0.20	0.10
0402	1.00± 0.05	0.50± 0.05	0.55	0.30	0.15
0603	1.60± 0.10	0.80± 0.10	1.00	0.40	0.15
0805	2.00± 0.20	1.25± 0.20	1.45	0.70	0.20
1206	3.20± 0.30	1.60± 0.20	1.80	1.50	0.30
1210	3.20± 0.30	2.50± 0.20	2.70	1.60	0.30
1808	4.60± 0.30	2.00± 0.20	2.20	2.50	0.30
1812	4.60± 0.30	3.20± 0.30	3.00	2.50	0.30
1825	4.60± 0.30	6.35± 0.40	2.60	2.50	0.30
2208	5.70± 0.40	2.00± 0.20	2.20	3.50	0.30
2211	5.70± 0.40	2.80± 0.40	3.00	3.50	0.30
2220	5.70± 0.40	5.00± 0.40	3.00	3.50	0.30
2225	5.70± 0.40	6.35± 0.40	3.00	3.50	0.30

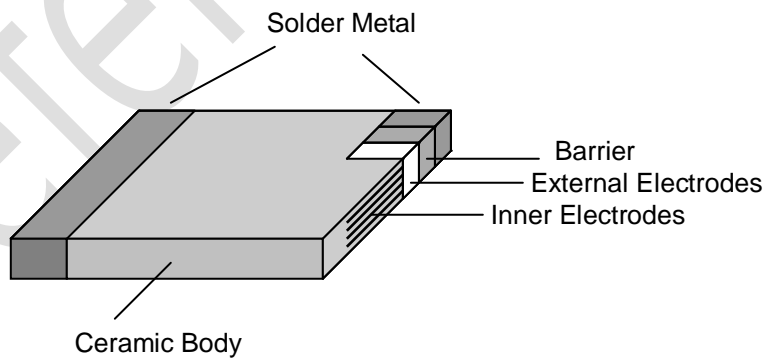
6.2 Termination Type :

7. Performance

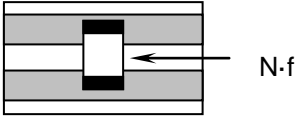
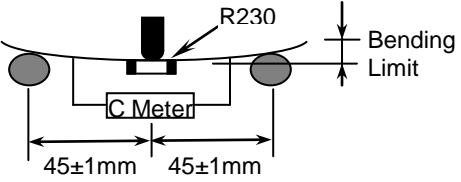
No.	Item	Specification	Test Condition			
1	Visual	No abnormal exterior appearance	Visual Inspection			
2	Dimension	See Page 3	Visual Inspection			
3	Insulation Resistance	10,000MΩ or 500/C Ω whichever is smaller for rated voltage>10V and greater 100/C Ω for rated voltage≤10V.	Applied Voltage: Rated Voltage Charge Time : 60±5 sec. Charge-Discharge current shall be less than 50mA current.			
4	Capacitance	Within The Specified Tolerance	Class I :			
5	Q	Class I More Than 30pF : Q ≥ 1000 30pF & Below: Q ≥ 400+20C (C : Capacitance , pF)	Char	Frequency	Voltage	
			C ≤ 1000pF	1MHz±10%	1.0±0.2Vrms	
			C > 1000pF	1KHz±10%		
	Tanδ	Class II X7R/X7S/X6S/X5R/X5S: shell meet the value in table 1 Y5V/Y5U/Z5U : 0.2 max.	Class II :			
			Char	Frequency	Voltage	
			C ≤ 10uF	1KHz±10%	*1.0±0.2Vrms or 0.5±0.2Vrms	
C > 10uF	120Hz±20%	0.5±0.2Vrms				
			Perform a heat temperature at 150±5°C for 30min then place room temp. for 24±2hr. * Depend on the individual parts.			
6	Withstanding Voltage	No dielectric breakdown or mechanical breakdown	250% of the rated voltage for 1~5 sec. charge/discharge Current is less than 50mA.			
7	Temperature Capacitance Coefficient	Class I	Char.	Temp. Range	Cap. Change(%)	Class I : $\frac{C_2 - C_1}{C_1(T_2 - T_1)} \times 100\%$
			NPO	-55°C ~ +125°C	± 30 ppm/°C	
		Class II	Char.	Temp. Range	Cap. Change(%)	Class II : $\frac{C_2 - C_1}{C_1} \times 100\%$
			X7R	-55°C ~ +125°C	± 15%	
			X7S	-55°C ~ +125°C	± 22%	
			X6S	-55°C ~ +105°C	± 22%	
			X5R	-55°C ~ +85°C	± 15%	
			X5S	-55°C ~ +85°C	± 22%	
			Y5V	-30°C ~ +85°C	+22% ~ -82%	
			Y5U	-30°C ~ +85°C	+22% ~ -56%	
Z5U	+10°C ~ +85°C	+22% ~ -56%				
			T1: Standard Temperature(25°C) T2: Test Temperature C1:Capacitance At Standard Temperature(25°C) C2: Capacitance At Test Temperature (T2) 0.2Vrms shall be applied.			
8	Adhesive Strength Of Termination	No indication of peeling shall occur on the terminal electrode.	Pull force shall be applied for 10± 1 second. ≤ 0603----5N(≒ 0.5 Kg-f) > 0603----10N(≒ 1.0 Kg-f) 			
9	Resistance to Flexure of Substrate	Appearance	No mechanical damage or capacitance change more than the following table.			The board shall be bend 1.0mm with a rate of 1.0 mm/sec. 
		C-Meter	Capacitance Change			
	Char.	Cap. Change				
	NPO(N)	≤ ± 5.0% of initial value				
	X7R (X)	≤ ± 12.5% of initial value				
	X7S (R)					
	X6S (S)					
	X5R (B)					
	X5S (D)					
	Y5V (Y)	≤ ± 30.0% of initial value				
Y5U (E)						
Z5U (Z)						

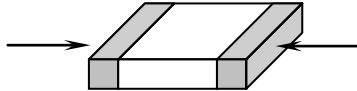
No.	Item	Specification	Test Condition															
10	Solderability	More than 90% of the terminal surface is to be soldered newly, so metal part does not come out or dissolve. 	Solder Temperature : 245± 5°C Dip Time : 5 ± 0.5sec Immersing Speed : 25±10% mm/s Solder : Lead Free Solder Flux : Rosin Preheat : At 80~120 °C for 10~30sec.															
11	Resistance To Soldering Heat	Appearance	No mechanical damage shall occur.															
		Capacitance	Class I (NPO)	Within ± 2.5% or ± 0.25pF whichever is larger of initial value														
			X7R/X7S/X6S X5R/X5S	≤ ±7.5% of initial value														
			Y5V/Y5U/Z5U	≤ ±20% of initial value														
		Q Class I	To satisfy the specified initial value															
		Tanδ Class II	X7R/X7S/X6S/X5R/X5S: shell meet the value in table 1 Y5V/Y5U/Z5U : 0.2 max.															
Insulation Resistance	To satisfy the specified initial value																	
12	Temperature Cycle	Appearance	No mechanical damage shall occur.															
		Capacitance	Class I (NPO)	Within ± 2.5% or ± 0.25pF whichever is larger of initial value														
			X7R/X7S/X6S X5R/X5S	≤ ±7.5% of initial value														
			Y5V/Y5U/Z5U	≤ ±20% of initial value														
		Q Class I	To satisfy the specified initial value															
		Tanδ Class II	X7R/X7S/X6S/X5R/X5S: shell meet the value in table 1 Y5V/Y5U/Z5U : 0.2 max.															
Insulation Resistance	To satisfy the specified initial value																	
13	Humidity	Appearance	No mechanical damage shall occur.															
		Capacitance	Characteristic	Cap. Change														
			Class I (NPO)	Within ± 5.0% or ± 0.5pF whichever is larger of initial value														
			X7R/X7S/X6S X5R/X5S	≤ ±12.5% of initial value														
		Y5V/Y5U/Z5U	≤ ±30% of initial value															
		Q Class I	30pF & Over : Q ≥ 350 10 to 30pF : Q ≥ 275+2.5C 30pF & Below: Q ≥ 200+10C															
Tanδ Class II	X7R/X7S/X6S/X5R/X5S: shell meet the value in table 1 Y5V/Y5U/Z5U : 0.4 max.																	
Insulation Resistance	1000MΩ or 50/C Ω whichever is smaller for rated voltage>10V and greater 10/C Ω for rated voltage ≤ 10V. (C in Farad)																	
			Class II capacitor shall be set for 48±4 hours at room temperature after one hour heat treatment at 150 +0/-10°C before initial measure. Preheat : at 150± 10°C for 60~120sec. Dip : solder temperature of 260± 5°C Dip Time : 10 ± 1sec. Immersing Speed : 25±10% mm/s Flux : Rosin Measure at room temperature after cooling for Class I : 24 ± 2 Hours Class II : 48 ± 4 Hours															
			Class II capacitor shall be set for 48±4 hours at room temperature after one hour heat treatment at 150 +0/-10°C before initial measure. Capacitor shall be subjected to five cycles of the temperature cycle as following: <table border="1" data-bbox="1002 1214 1471 1393"> <thead> <tr> <th>Step</th> <th>Temp.(°C)</th> <th>Time(min)</th> </tr> </thead> <tbody> <tr> <td>1</td> <td>Min Rated Temp. +0/-3</td> <td>30</td> </tr> <tr> <td>2</td> <td>25</td> <td>3</td> </tr> <tr> <td>3</td> <td>Max Rated Temp. +3/-0</td> <td>30</td> </tr> <tr> <td>4</td> <td>25</td> <td>3</td> </tr> </tbody> </table> Measure at room temperature after cooling for Class I : 24 ± 2 Hours Class II : 48 ± 4 Hours	Step	Temp.(°C)	Time(min)	1	Min Rated Temp. +0/-3	30	2	25	3	3	Max Rated Temp. +3/-0	30	4	25	3
Step	Temp.(°C)	Time(min)																
1	Min Rated Temp. +0/-3	30																
2	25	3																
3	Max Rated Temp. +3/-0	30																
4	25	3																
			Class II capacitor shall be set for 48± 4 hours at room temperature after one hour heat treatment at 150 +0/-10 °C before initial measure. Temperature : 40± 2°C Relative Humidity : 90 ~ 95%RH Test Time : 500 +12/-0Hr Measure at room temperature after cooling for Class I : 24 ± 2 Hours Class II : 48 ± 4 Hours															

No.	Item	Specification	Test Condition	
14	Humidity Load	Appearance	No mechanical damage shall occur.	
		Capacitance	Characteristic	Cap. Change
			Class I (NPO)	Within $\pm 7.5\%$ or $\pm 0.75\text{pF}$ whichever is larger of initial value
			X7R/X7S/X6S X5R/X5S	$\leq \pm 12.5\%$ of initial value
			Y5V/Y5U/Z5U	$\leq \pm 30\%$ of initial value
		Q Class I	30pF & Over : $Q \geq 350$ 10 to 30pF : $Q \geq 275+2.5C$ 30pF & Below: $Q \geq 200+10C$	
		Tan δ Class II	X7R/X7S/X6S/X5R/X5S: shell meet the value in table 1 Y5V/Y5U/Z5U : 0.4 max.	
Insulation Resistance	500M Ω or 25/C Ω whichever is smaller for rated voltage >10V and greater 5/C Ω for rated voltage $\leq 10V$. (C in Farad)			
15	High Temperature Load (Life Test)	Appearance	No mechanical damage shall occur.	
		Capacitance	Characteristic	Cap. Change
			Class I (NPO)	Within 5.0% or $\pm 0.5\text{pF}$ whichever is larger of initial value
			X7R/X7S/X6S X5R/X5S	$\leq \pm 12.5\%$ of initial value
			Y5V/Y5U/Z5U	$\leq \pm 30\%$ of initial value
		Q Class I	30pF & Over : $Q \geq 350$ 10 to 30pF : $Q \geq 275+2.5C$ 30pF & Below: $Q \geq 200+10C$	
		Tan δ Class II	X7R/X7S/X6S/X5R/X5S: shell meet the value in table 1 Y5V/Y5U/Z5U : 0.4 max.	
Insulation Resistance	1,000M Ω or 50/C Ω whichever is smaller for rated voltage >10V and greater 10/C Ω for rated voltage $\leq 10V$. (C in Farad)			
16	Vibration	Appearance	No mechanical damage shall occur	
		Capacitance	Within the specified tolerance	
		Q Class I	To satisfy the specified initial value	
		Tan δ Class II	X7R/X7S/X6S/X5R/X5S: shell meet the value in table 1 Y5V/Y5U/Z5U : 0.2 max.	
			Solder the capacitor on P.C. board.	
			Vibrate the capacitor with amplitude of 1.5mm P-P changing the frequencies from 10Hz to 55Hz and back to 10Hz in about 1 min.	
			Repeat this for 2 hours each in 3 perpendicular directions.	

Table 1

emp char: X7R,X7S,X6S,X5R,X5S

	Rated voltage	Capacitance Range	Tanδ (MAX)	
			5. Initial 16.Vibration 11.Resistance to solder heat 12.Temperature cycle	13.Humidity 14.Humidity loading 15.High temperature loading
0201	DC 6.3V	$C \leq 0.01\mu\text{F}$	10.0%	20.0%
		$C = 0.1\mu\text{F}$	15.0%	25.0%
	DC 10V	$C \leq 0.01\mu\text{F}$	10.0%	20.0%
	DC 16V	$C \leq 3.3\text{nF}$	10.0%	20.0%
	DC 25V	$C \leq 2.2\text{nF}$	10.0%	20.0%
0402	DC 6.3V	$C \leq 0.22\mu\text{F}$	10.0%	20.0%
		$C \leq 2.2\mu\text{F}$	15.0%	25.0%
	DC 10V	$C \leq 0.1\mu\text{F}$	10.0%	20.0%
	DC 16V	$C \leq 1.0\mu\text{F}$	15.0%	25.0%
	DC 25V	$C \leq 0.47\mu\text{F}$	15.0%	20.0%
0603	DC 6.3V	$C < 4.7\mu\text{F}$	10.0%	20.0%
		$C \leq 10\mu\text{F}$	15.0%	25.0%
	DC 10V	$C < 4.7\mu\text{F}$	10.0%	20.0%
	DC 16V	$C \leq 2.2\mu\text{F}$	10.0%	20.0%
	DC 25V	$C \leq 1.0\mu\text{F}$	10.0%	20.0%
0805	DC 6.3V	$C < 10\mu\text{F}$	10.0%	20.0%
		$C \leq 22\mu\text{F}$	15.0%	25.0%
	DC 10V	$C \leq 4.7\mu\text{F}$	10.0%	20.0%
	DC 16V	$C \leq 4.7\mu\text{F}$	10.0%	20.0%
	DC 25V	$C \leq 4.7\mu\text{F}$	10.0%	20.0%
1206	DC 6.3V	$C < 10\mu\text{F}$	10.0%	20.0%
		$C \leq 100\mu\text{F}$	15.0%	25.0%
	DC 10V	$C \leq 47\mu\text{F}$	10.0%	20.0%
	DC 16V	$C \leq 22\mu\text{F}$	10.0%	20.0%
	DC 25V	$C \leq 10\mu\text{F}$	10.0%	20.0%
1210	DC 6.3V	$C \leq 47\mu\text{F}$	10.0%	20.0%
		$47\mu\text{F} < C \leq 100\mu\text{F}$	15.0%	25.0%
	DC 10V	$C \leq 22\mu\text{F}$	10.0%	20.0%
	DC 16V	$C \leq 10\mu\text{F}$	10.0%	20.0%
	DC 25V	$C \leq 10\mu\text{F}$	10.0%	20.0%
1812	DC 6.3V	All Capacitance	10.0%	20.0%
			10.0%	20.0%
	DC 10V		10.0%	20.0%
	DC 16V		10.0%	20.0%
	DC 25V		10.0%	20.0%
2220	DC 35V	All Capacitance	10.0%	20.0%
			10.0%	20.0%

Fig.1
P.C. Board for Bending Strength Test

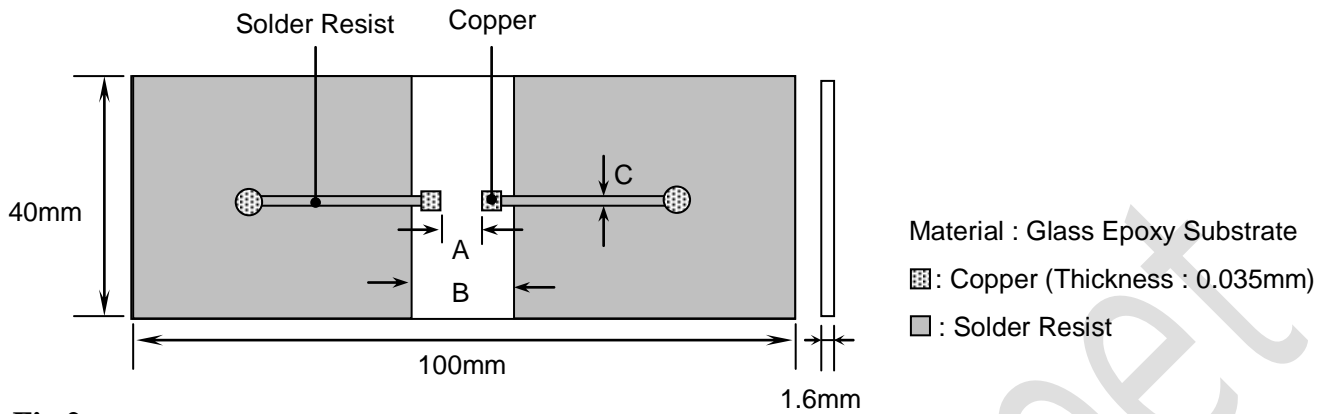
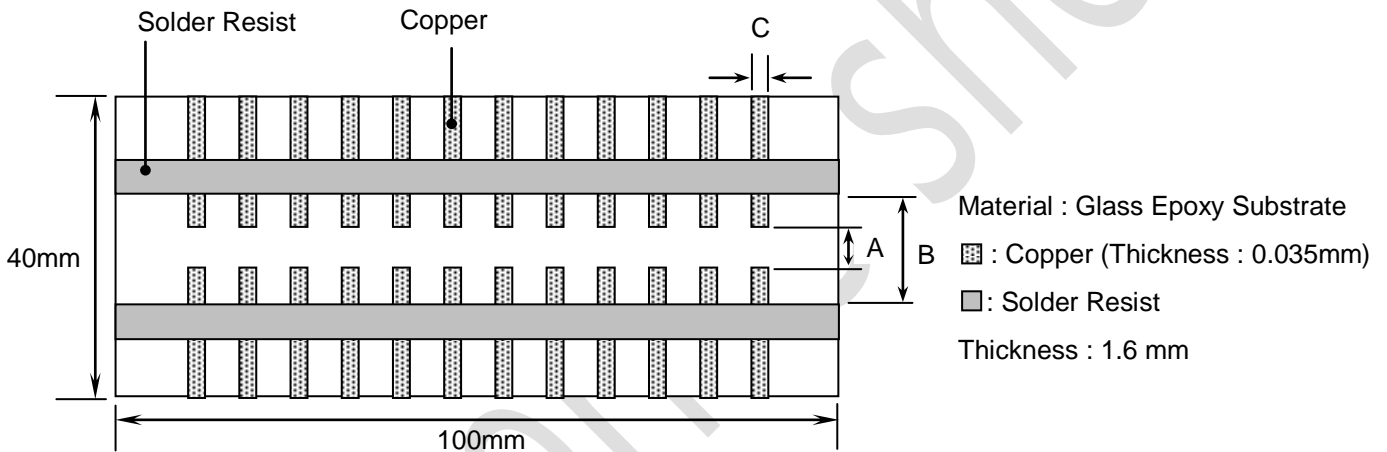

Fig.2
Test Substrate



Unit:mm

Type	A	B	C
0201	0.2	0.9	0.4
0402	0.5	1.5	0.6
0603	1.0	3.0	1.0
0805	1.2	4.0	1.6
1206	2.2	5.0	2.0
1210	2.2	5.0	2.9
1808	3.5	7.0	2.5
1812	3.5	7.0	3.7
2208	4.5	8.0	2.5
2211	4.5	8.0	3.0
2220	4.5	8.0	5.6

8. Packing

8.1 Bulk Packing

According to customer request.

8.2 Chip Capacitors Tape Packing

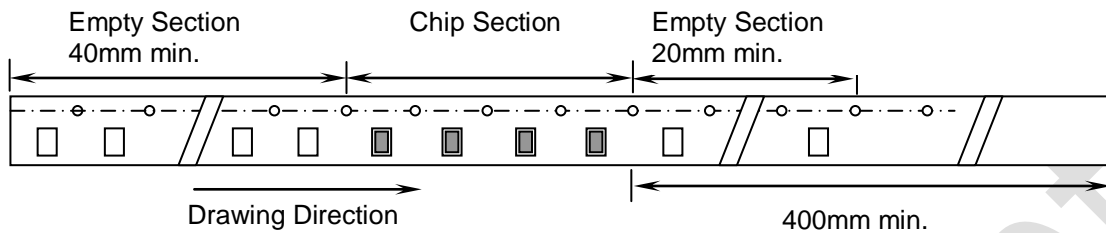

8.3 Material And Quantity

Tape	0201	0402	0603/0805	
Material	$T \leq 0.33\text{mm}$	$T \leq 0.55\text{mm}$	$T \leq 0.90\text{mm}$	$T > 0.90\text{mm}$
Paper	15,000 pcs/Reel	10,000 pcs/Reel	4,000 pcs/Reel	NA
Plastic	NA	NA	NA	3,000 pcs/Reel

Tape	1206		
Material	$T \leq 0.90\text{mm}$	$0.90\text{mm} < T \leq 1.25\text{mm}$	$T > 1.25\text{mm}$
Paper	4,000 pcs/Reel	NA	NA
Plastic	NA	3,000 pcs/Reel	2,000 pcs/Reel

Tape	1808/1210		
Material	$T \leq 1.25\text{mm}$	$1.25\text{mm} < T \leq 2.40\text{mm}$	$T > 2.40\text{mm}$
Paper	NA	NA	NA
Plastic	3000 pcs/Reel	2000 pcs/Reel	500/1,000 pcs/Reel

Tape	1812/2211/2220		1825/2225		2208
Material	$T \leq 2.20\text{mm}$	$T > 2.20\text{mm}$	$T \leq 2.20\text{mm}$	$T > 2.20\text{mm}$	$T \leq 2.20\text{mm}$
Paper	NA	NA	NA	NA	NA
Plastic	1000 pcs/Reel	700 pcs/Reel	700 pcs/Reel	400 pcs/Reel	1000 pcs/Reel

NA : Not Available

8.4 Cover Tape Reel Off Force

8.4.1 Peel-Off Force

$5 \text{ g}\cdot\text{f} \leq \text{Peel-Off Force} \leq 70 \text{ g}\cdot\text{f}$

8.4.2 Measure Method

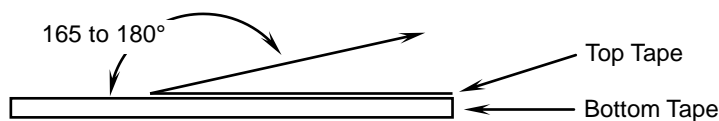

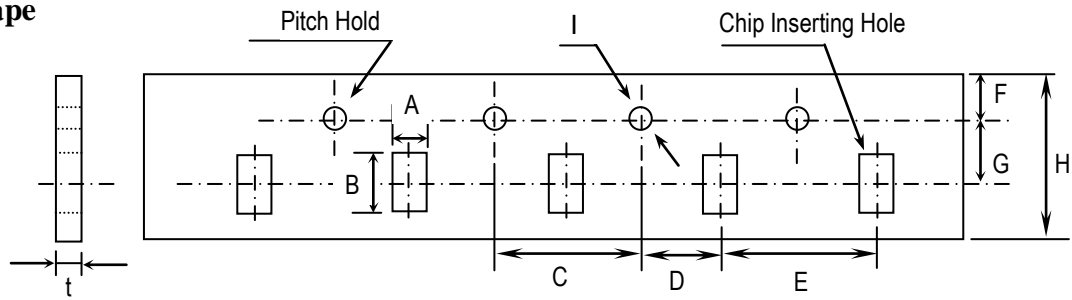
8.5 Paper Tape

Unit:mm

TYPE	A	B	C	D	E
0201	0.37 ± 0.1	0.67 ± 0.1	4.00 ± 0.1	2.00 ± 0.05	2.00 ± 0.1
0402	0.61 ± 0.1	1.20 ± 0.1			4.00 ± 0.1
0603	1.10 ± 0.2	1.90 ± 0.2			4.00 ± 0.1
0805	1.50 ± 0.2	2.30 ± 0.2			4.00 ± 0.1
1206	1.90 ± 0.2	3.50 ± 0.2			4.00 ± 0.1
1210	2.90 ± 0.2	3.60 ± 0.2			4.00 ± 0.1

TYPE	F	G	H	I	t
0201	1.75 ± 0.10	3.50 ± 0.05	8.0 ± 0.30	$\phi 1.50 +0.10/-0$	1.10 max.
0402					
0603					
0805					
1206					
1210					

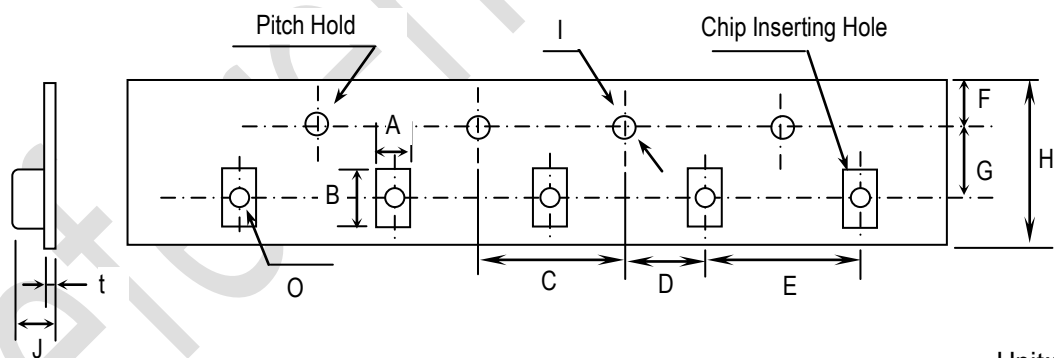
8.6 Plastic Tape

Unit:mm

Type	A	B	C	D	E	F
0805	1.5 ± 0.2	2.3 ± 0.2	4.0 ± 0.1	2.0 ± 0.05	4.0 ± 0.1	1.75 ± 0.1
1206	1.9 ± 0.2	3.5 ± 0.2				
1210	2.9 ± 0.2	3.6 ± 0.2				
1808	2.5 ± 0.2	4.9 ± 0.2				
1812	3.6 ± 0.2	4.9 ± 0.2				
1825	6.9 ± 0.2	4.9 ± 0.2			8.0 ± 0.1	
2208	2.5 ± 0.2	6.1 ± 0.2				
2211	3.2 ± 0.2	6.1 ± 0.2				
2220	5.4 ± 0.2	6.1 ± 0.2				
2225	6.9 ± 0.2	6.1 ± 0.2				

Type	G	H	I	J	t	O
0805	3.5± 0.05	8.0± 0.3	φ 1.5+0.1/-0	3.0 max.	0.3 max.	1.0± 0.1
1206				4.0 max.		
1210						
1808	5.5± 0.05	12.0 ± 0.3		4.0 max.		1.5± 0.1
1812						
1825						
2208						
2211						
2220						
2225						

8.7 Reel Dimensions

Reel Material : Polystyrene

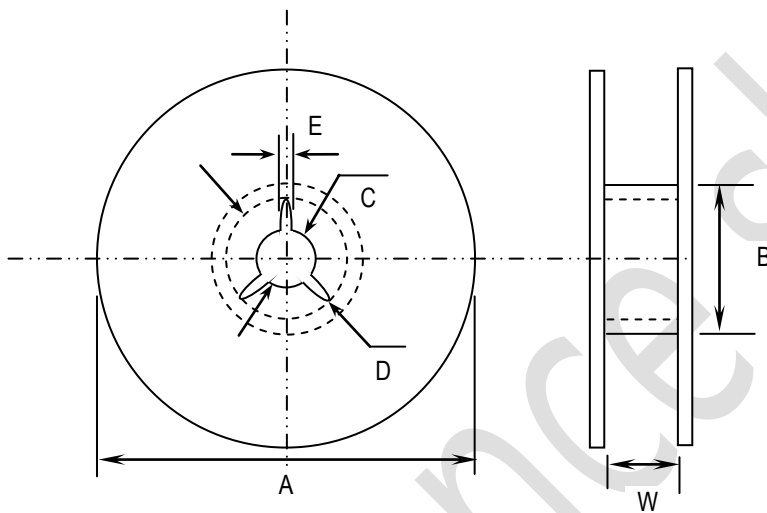

Unit:mm

Type	A	B	C	D	E	W
0201	φ 382 max	φ 50 min	φ 13± 0.5	φ 21± 0.8	2.0±0.5	10± 0.15
0402						
0603						
0805						
1206						
1210						
1808	φ 178±0.2	φ 60±0.2				13±0.3
1812						
1825						
2208						
2211						
2220						
2225						

Precautionary Notes:

1. Storage

Store the capacitors where the temperature and relative humidity don't exceed 40°C and 70%RH. We recommend that the capacitors be used within 12 months from the date of manufacturing. Store the products in the original package and do not open the outer wrapped, polyethylene bag, till just before usage. If it is open, seal it as soon as possible or keep it in a desiccant with a desiccation agent.

2. Construction of Board Pattern

Improper circuit layout and pad/land size may cause excessive or not enough solder amount on the PC board. Not enough solder may create weak joint, and excessive solder may increase the potential of mechanical or thermal cracks on the ceramic capacitor. Therefore we recommend the land size to be as shown in the following table: 2.1

Size and recommend land dimensions for reflow soldering

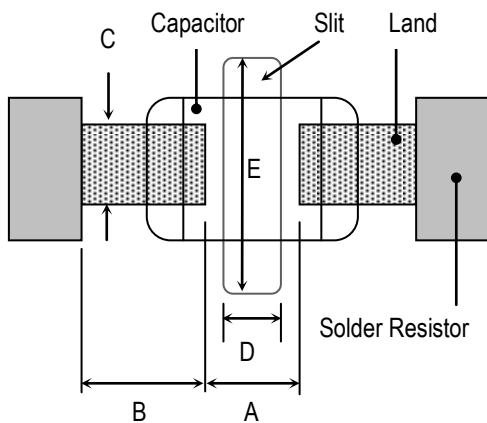

EIA Code	Chip (mm)		Land (mm)				
	L	W	A	B	C	D	E
0201	0.60	0.30	0.2~0.3	0.2~0.4	0.2~0.4	--	--
0402	1.00	0.50	0.3~0.5	0.3~0.5	0.4~0.6	--	--
0603	1.60	0.80	0.4~0.6	0.6~0.7	0.6~0.8	--	--
0805	2.00	1.25	0.7~0.9	0.6~0.8	0.8~1.1	--	--
1206	3.20	1.60	2.2~2.4	0.8~0.9	1.0~1.4	1.0~2.0	3.2~3.7
1210	3.20	2.50	2.2~2.4	1.0~1.2	1.8~2.3	1.0~2.0	4.1~4.6
1808	4.60	2.00	2.8~3.4	1.8~2.0	1.5~1.8	1.0~2.8	3.6~4.1
1812	4.60	3.20	2.8~3.4	1.8~2.0	2.3~3.0	1.0~2.8	4.8~5.3
1825	4.60	6.35	2.8~3.4	1.8~2.0	5.1~5.8	1.0~4.0	7.1~8.3
2208	5.70	2.00	4.0~4.6	2.0~2.2	1.5~1.8	1.0~4.0	3.6~4.1
2211	5.70	2.80	4.0~4.6	2.0~2.2	2.0~2.6	1.0~4.0	4.4~4.9
2220	5.70	5.00	4.0~4.6	2.0~2.2	3.5~4.8	1.0~4.0	6.6~7.1
2225	5.70	6.35	4.0~4.6	2.0~2.2	5.1~5.8	1.0~4.0	7.1~8.3

2.2 Mechanical strength varies according to location of chip capacitors on the P.C. board.

Design layout of components on the PC board such a way to minimize the stress imposed on the components, upon flexure of the boards in depanelization or other processes.

Component layout close to the edge of the board or the "depanelization line" is not recommended.

Susceptibility to stress is in the order of: $a > b > c$ and $d > e$

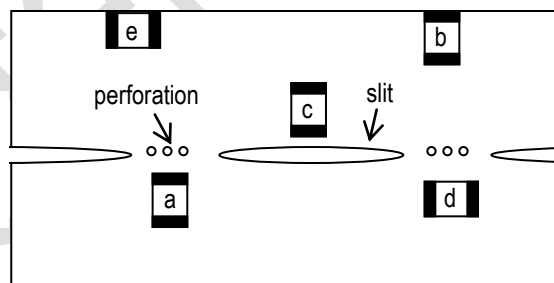

2.3 Layout Recommendation

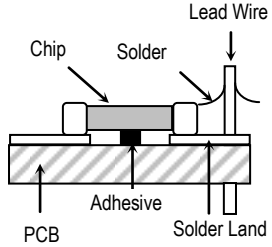
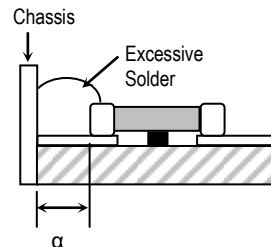
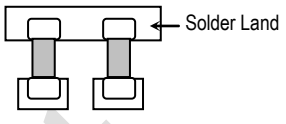
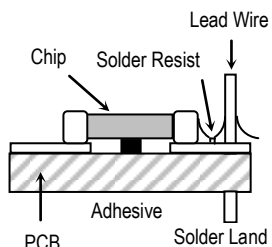
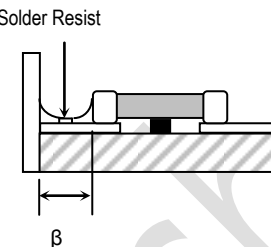
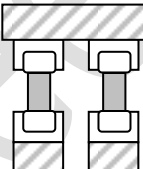
Example	Use of Common Solder Land	Solder With Chassis	Use of Common Solder Land With Other SMD
Need to Avoid			
Recommendation			

3. Mounting

3.1 Sometimes crack is caused by the impact load due to suction nozzle in pick and place operation.

In pick and place operation, if the low dead point is too low, excessive stress is applied to component. This may cause cracks in the ceramic capacitor, therefore it is required to move low dead point of a suction nozzle to the higher level to minimize the board warp age and stress on the components. Nozzle pressure is typically adjusted to 1N to 3N (static load) during the pick and place operation.

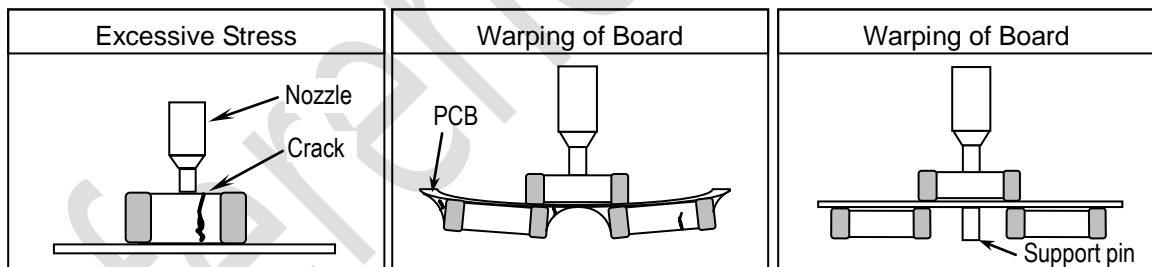
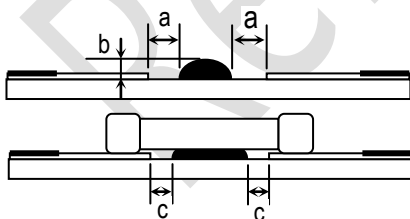
3.2 Amount of Adhesive

Example : 0805 & 1206

a	0.2mm min.
b	70 ~ 100 μm
c	Do not touch the solder land

4. Soldering

4.1. Wave Soldering

Most of components are wave soldered with solder at 230 to 250°C. Adequate care must be taken to prevent the potential of thermal cracks on the ceramic capacitors. Refer to the soldering methods below for optimum soldering benefits.

Recommend flow soldering temperature Profile

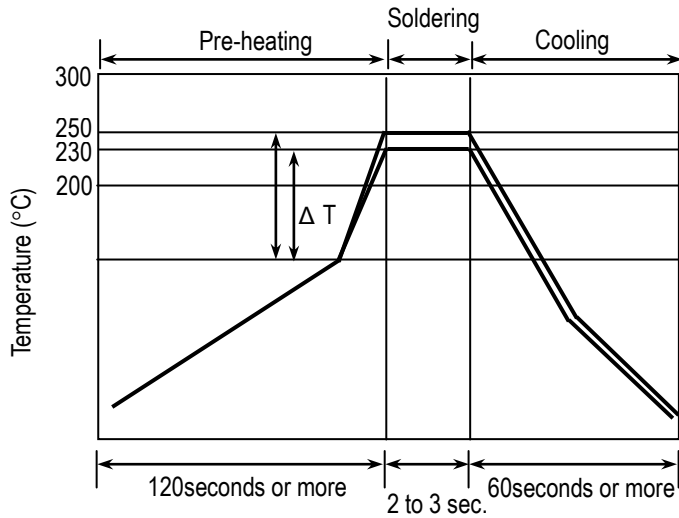

Soldering Method	Change in Temp.(°C)
1206 and Under	$\Delta T \leq 100\sim 130$ max.

To optimize the result of soldering, proper preheating is essential:

- 1) Preheat temperature is too low
 - a. Flux flows to easily
 - b. Possibility of thermal cracks
- 2) Preheat temperature is too high
 - a. Flux deteriorates even when oxide film is removed
 - b. Causes warping of circuit board
 - c. Loss of reliability in chip and other components

Cooling Condition:

Natural cooling using air is recommended. If the chips are dipped into a solvent for cleaning, the temperature difference (ΔT) between the solvent and the chips must be less than 100°C.

4.2 Reflow Soldering

Preheat and gradual increase in temperature to the reflow temperature is recommended to decrease the potential of thermal crack on the components. The recommended heating rate depends on the size of component, however it should not exceed 3°C/Sec.

Recommend reflow profile for Lead-Free soldering temperature Profile (MIL-STD-202G #210F)

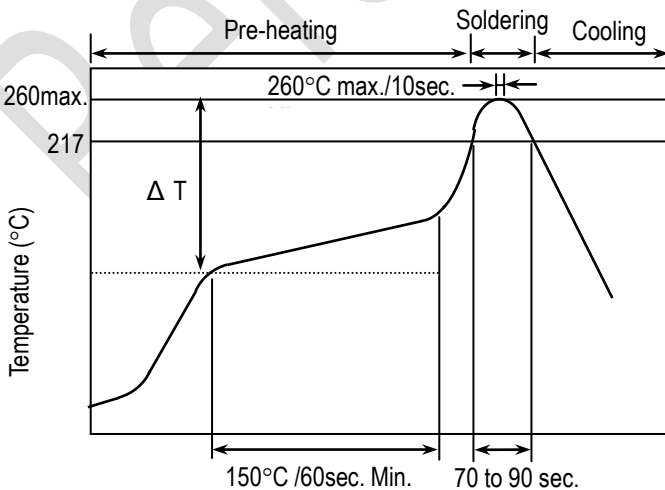

※ The cycles of soldering : Twice (max.)

Soldering Method	Change in Temp.(°C)
1206 and Under	$\Delta T \leq 190$ °C
1210 and Over	$\Delta T \leq 130$ °C

4.3 Hand Soldering

Sudden temperature change in components, results in a temperature gradient recommended in the following table, and therefore may cause internal thermal cracks in the components. In general a hand soldering method is not recommended unless proper preheating and handling practices have been taken. Care must also be taken not to touch the ceramic body of the capacitor with the tip of solder iron.

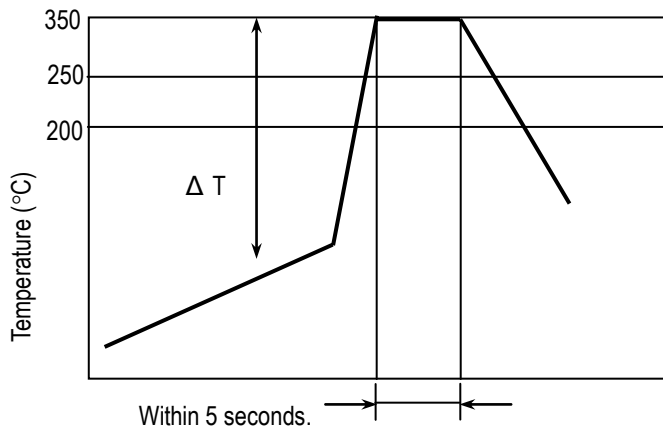

Soldering Method	Change in Temp.(°C)
1206 and Under	$\Delta T \leq 150\text{ }^{\circ}\text{C}$
1210 and Over	$\Delta T \leq 130\text{ }^{\circ}\text{C}$

How to Solder Repair by Solder Iron

- 1) Selection of the soldering iron tip
 - The required temperature of solder iron for any type of repair depends on the type of the tip, the substrate material, and the solder land size.
- 2) recommended solder iron condition
 - a.) Preheating Condition : Board and components should be preheated sufficiently at 150°C or over, and soldering should be conducted with soldering iron as boards and components are maintained at sufficient temperatures.
 - b.) Soldering iron power shall not exceed 30 W.
 - c.) Soldering iron tip diameter shall not exceed 3mm.
 - d.) Temperature of iron tip shall not exceed 350°C to perform the process within 5 seconds. (refer to MIL-STD-202G)
 - f.) Do not touch the ceramic body with the tip of solder iron. Direct contact of the soldering iron tip to ceramic body may cause thermal cracks.
 - g.) After soldering operation, let the products cool down gradually in the room temperature.

5. Handling after chip mounted

5.1 Proper handling is recommended, since excessive bending and twist of the board, depends on the orientation of the chip on the board, may induce mechanical stress and cause internal crack in the capacitor.

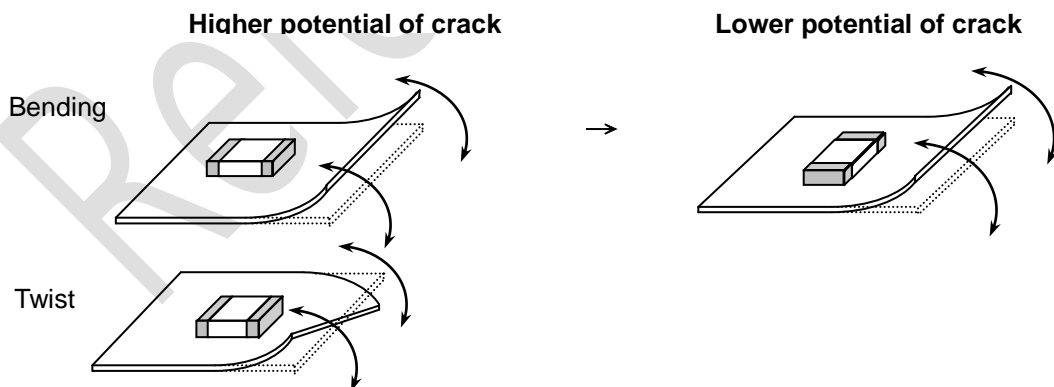

5.2 There is a potential of crack if board is warped due to excessive load by check pin

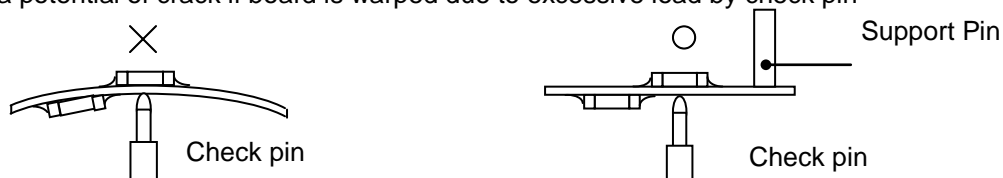

5.3 Mechanical stress due to warping and torsion.

- (a) Crack occurrence ratio will be increased by manual separation.
- (b) Crack occurrence ratio will be increased by tensile force , rather than compressive force.

× :Tensile Stress

○ :Compressive Stress

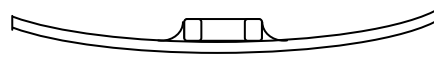

Capacitor Stress Analysis

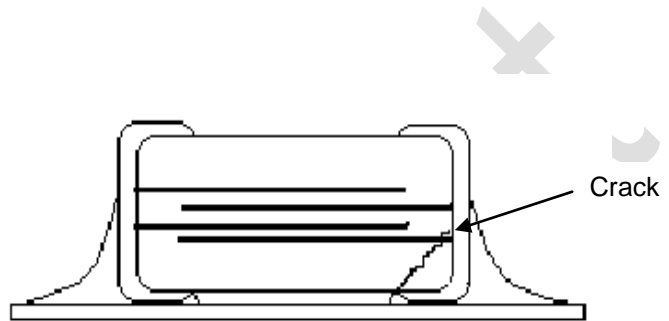
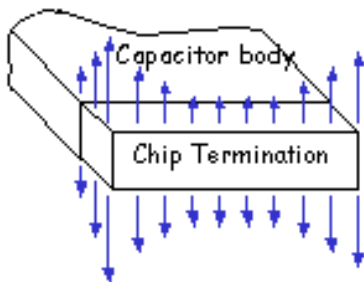

6. Handling of Loose Chip Capacitor

6.1 If dropped the chip capacitor may crack.

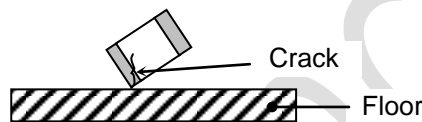

6.2 In piling and stacking of the P.C. boards after mounting for storage or handling, the corner of the P.C. board may hit the chip capacitor mounted on another board to cause crack.

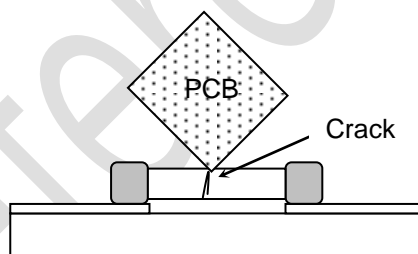

7. Safekeeping condition and period

For safekeeping of the products, we recommend to keep the storage temperature between +5 to +40°C and under humidity of 20 to 70% RH. The shelf life of capacitors is 12 months.